



www.eversan.com

MODEL 9872

AT BAT	BALL		STRIKE		OUT		H / E						
25	3		2		2		E3						
<small>EVERSAN</small>	1	2	3	4	5	6	7	8	9	10	RUNS	HITS	ERR.
GUEST	0	0	3	1	0	0	3	0	1		8	18	2
HOME	2	2	2	0	3	2	1	2			14	24	0

BASEBALL/SOFTBALL SCOREBOARD

Instruction Manual

Address: 34 Main Street, Whitesboro, NY 13492

Phone: 315-736-3967 • Toll Free: 800-383-6060 • Fax: 315-736-4058

SCOREBOARDS • TIMERS • MESSAGE SIGNS • VIDEO DISPLAYS • WIRELESS

Table of Contents

Check List	1
Installation Instructions.....	2
Instructions for Wiring	3
Installation Diagram	4
Wireless Operation	5
Operating Instructions	5
Cabled/Wireless Console	8
Maintenance of Outdoor Scoreboards	9
Removal and Replacement Procedures	9



Page 1

MODEL 9872

**BASEBALL SCOREBOARD
INSTALLATION INSTRUCTIONS**

These instructions must be followed to ensure correct operation. The warranty will be violated and considered null if inspection and operating procedures are disregarded.

Should you require assistance or have any questions, please call 800-383-6060.

Check List

- Model 9872 Scoreboard
- Control Console with LCD readout
- Two Conductor Control Cable (Cabled Systems Only)
- Mounting Brackets (6)
- Support Brackets (2)
- Antenna (2) (Wireless Systems Only)

NOTE: Please check that these items are available prior to initial test of the scoreboard. If you are missing any items, please call **(800) 383-6060 for assistance.**

Customer Shipping Inspection

- A. Unpack scoreboard.
- B. Unpack cable and control console.
Plug the console cable and console into the console connector on back (see diagram)
- C. Testing - Remove four screws holding the panel on the 120VAC access box on the back of the scoreboard. There is a standard 120VAC plug for testing. After testing cut connector provided. Match colors on power cable provided to three wires on 120V box. This board operates on 120VAC at approximately 6 AMP.

**NOTE: FAILURE TO TEST SCOREBOARD PRIOR TO INSTALLATION
WILL VOID ALL WARRANTIES.**

Power scoreboard using 120VAC or optional 120VAC-power inverter and test scoreboard using the operating instructions provided.

**SHOULD THERE BE A MALFUNCTION OR SHIPPING DAMAGE,
NOTIFY THE SHIPPER AND EVERSAN IMMEDIATELY.**



INSTALLATION

1. It is recommended that a professional sign company be hired to install the scoreboard (see drawings). Eversan recommends a minimum depth of 4 ft. to 5ft. and 2 ½ FT. footer diameter. Soil conditions and local codes should be used to determine footer depth and diameter in your area.
2. Calculate the wind loading by standard formula for height and dimension of sign. Dimension of the sign is 7FT. High x 28FT. Wide, add height and/or width of any sponsor panels. Approximate weight is 1000lbs. **NOTE:** Check local codes for your area.
3. Prepare and sink I-beams, minimum I-Beam recommendation W 8 x 24 conforming to ASTM A36, align with plumb line and careful measurements.
4. Determine height of lowest point for scoreboard, minimum recommendation 8FT. Mark and align on all mounting beams parallel to visual ground sighting.
5. Drill and bolt (3/8 hardened bolts) or weld provided bottom Z-brackets to the posts as shown in the installation diagram.
6. Assemble the scoreboard on the ground and test according to the instructions. **Make sure to connect all the data lines to the number panels in each section and the two wire assemblies between the top and bottom of the scoreboard (see diagram).**
7. Lift scoreboard set onto Z bracket. Secure temporarily with a clamp if there are no additional sponsor panels. If there are sponsor panels use the panel brackets to secure the scoreboard and panels to the I-beam.
8. Place the top Z-brackets on the board and install in the same manner as the lower.
9. The board is now ready to be wired. Wireless systems must have the antenna installed on the front of the scoreboard. Just screw antenna into connector provided (near AT BAT).

INSTRUCTIONS FOR WIRING

1. Determine 120VAC entrance and run conduit to pre-installed electric box on back of scoreboard (see diagram).
2. The scoreboard draws under 6 amp but requires its own circuit breaker. Eversan, Inc. recommends using a 10-amp, GFCI breaker.

CAUTION: Cabled System Only

The data cable is a pre-wired, 2 conductor shielded, 22GA stranded cable. Any cable splicing should be color-coded or failure of the computer power supply will result. Continuity of the shield is essential in reducing possible damage due to lightning.

Electrical Specifications:

Electric outlets for scoreboards are always on a “clean” unused, switched breaker box. Pay close attention to the power source and connections. It is recommended that a key-switch or switched breaker box be used to turn off the system at the end of use each day. **The scoreboard should always be powered down when not in use.**

Power up Sequence:

120VAC Operation (Cabled System)

1. Plug the control console into the scoreboard using the cable provided. Any of the 2-pin connectors on the control console can be used. The connector for the scoreboard is located on the back (see diagram).
2. Power up the scoreboard using 120VAC, connection on back of scoreboard (see diagram).
3. The scoreboard will now go through diagnostics. Each digit will show an 8 and then go blank. The HOME and GUEST RUNS, HITS, and ERRORS will show zero.
4. Turn the control console on using the rocker switch located on the upper left side. The control console will display “EVERSAN SCORING SYSTEMS” for approx. 5 seconds. The console display will then read “ AT BAT=00” on the top line and “ BALL=0 STRK=0 OUT=0” on the bottom line. You are now ready to use the operating instructions to test all the functions.

Control Console Battery Operation 12 VDC (Optional):

1. Attach the battery connector to the 4 pin connector on the back of the control console (see diagram).
2. Connect the cigarette lighter plug into the Eversan battery pack or car cigarette lighter. Continue, starting with step 3 above.

WIRELESS OPERATION

Eversan, Inc.'s 2.4GHZ frequency hopping wireless control system allows for multiple scoreboards to be controlled separately or together within feet of each other.

Initializing the wireless system:

The following steps must be used to ensure proper communication from the 9872 wireless control console and each scoreboard you want to control. For a wireless system to work the scoreboard must always be turned on before the control console.

1. Turn the power to on each 9872 scoreboard that you want to control. The scoreboards should show the center segment of each digit illuminated.
2. Connect the antenna, 9VDC adapter provided or optional 12-volt battery, to the 9370/9872 wireless control console (see diagram for proper placement).

9872 MOUNTING DIAGRAM

INSTALLATION:

1. PLACE SUPPORT BRACKETS ON LOWER BACK OF BOTTOM SCOREBOARD.
2. LOCATE, ON I BEAMS, WHERE THE BOTTOM OF SCOREBOARD WILL BE AND MOUNT BOTTOM Z BRACKETS. EITHER BOLT Z BRACKET TO I BEAM OR WELD Z BRACKET TO I BEAM.
3. LIFT SCOREBOARD INTO Z BRACKETS, CHECK FOR LEVEL AND SECURE WITH TOP BRACKETS.

DETAIL

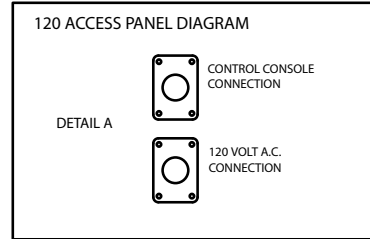

REAR VIEW OF SCOREBOARD

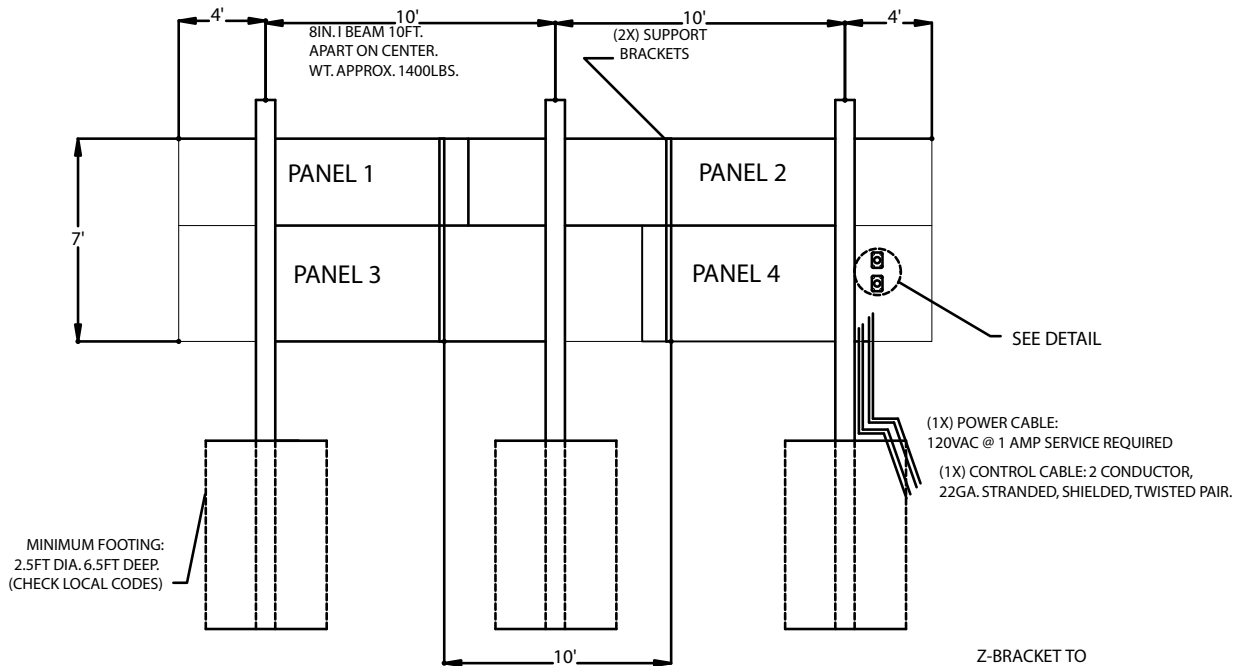

Z-BRACKET TO BE WELDED OR BOLTED TO BEAM

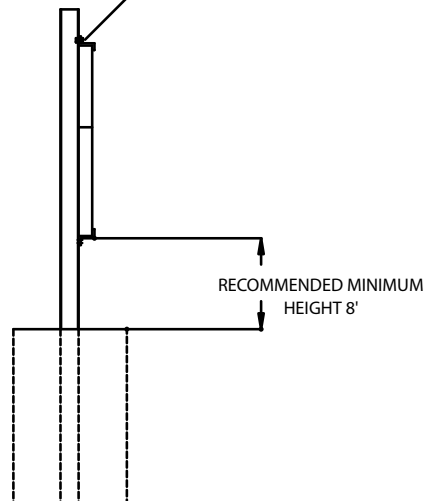

MODEL 9872 FINAL ASSEMBLY WITH W8 X 24 I BEAMS
 ADVERTISING PANEL NOT SHOWN. PANEL WILL CONNECT TO SCOREBOARD AND SUPPORT BRACKETS PRIOR TO TOP Z-BRACKET INSTALLATION.

- Turn on the control console. The control console will display "EVERSAN SCORING SYSTEMS" for approx. 5 seconds. The display will then show, "WIRELESS NETWORK SYSTEM ID = XX" for approx. 3 seconds. The console will then show "AT BAT=00" on the top line and "BALL=0 STRK=0 OUT=0" on the bottom line of the console display.
- While the control console is initializing it is also communicating with the scoreboard and the scoreboard will go through its diagnostic checkout. Each number position will flash eight (8) and then go blank. The scoreboard will then display zero in the HOME and GUEST RUNS, HITS, and ERR. See operating instructions.

Operating instructions:

- There are 3-operating windows for this scoreboard control console, AT BAT, GUEST and HOME.
- AT BAT WINDOW:** This is the primary use window. In this window you track BALLS, STRIKES and OUTS. By pushing and releasing the function button the function will increment. To clear BALLS and STRIKES push and release the CLEAR BS switch.

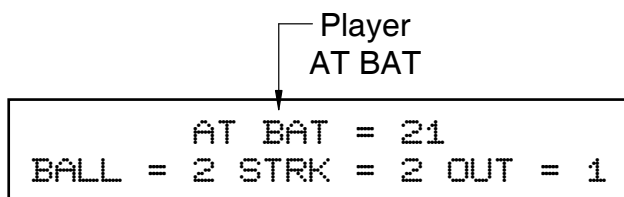

- GUEST WINDOW:** To enter this window push and release the GUEST push button switch. The functions used in this window: INNING, HIT and ERROR. Pushing and releasing the HIT or ERROR button will increment them by one, or use the 0-9 keypad to enter a 1-digit number for ERROR position or a two-digit number for hits total hits. The INNING push button moves the cursor on the control console display from inning to inning. Where the cursor is displayed is the inning score you are able to change using the 0-9 keypad. The cursor must be flashing to change the score. Total Runs are automatically tallied from the individual inning scores.

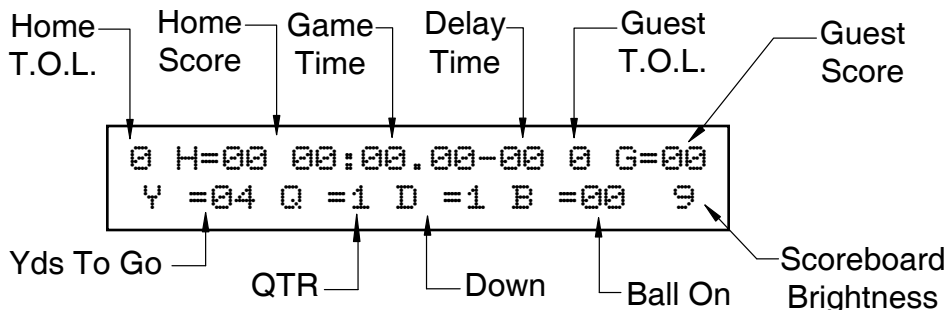

- HOME WINDOW:** To enter this window push and release the HOME push button switch. Every function is exactly like the GUEST WINDOW but will be displayed on the HOME portion of the scoreboard.

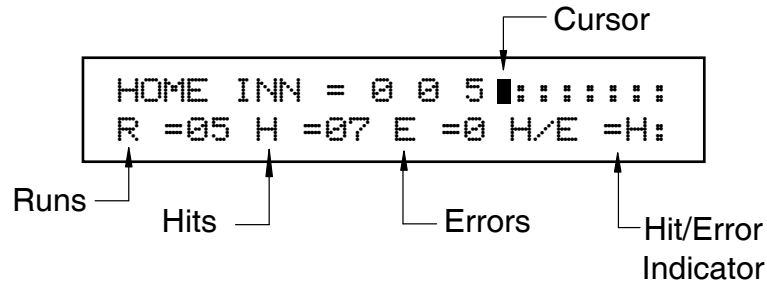

5. **BLANK:** This push button is used in conjunction with a function button. For example if you accidentally enter a score in the 5th inning for the home team and you are only in the 2nd inning, then move the cursor to the 5th inning and push BLANK, no number will appear in the 5th inning.
6. **BRIGHTNESS:** This button along with the 0-9 keypad allows the user to control the brightness of the scoreboard. Push and release the BRIGHTNESS button and then select any number 0-9, 0 being lowest brightness (numbers not lit) and 9 being full brightness.

Wireless control console battery operation (optional):

1. Turn the scoreboard power on.
2. Attach Eversan, Inc.'s special battery connector to the 4-pin connector on the back of the wireless control console (see diagram).
3. Connect the cigarette lighter plug into the Eversan battery pack or a car cigarette lighter.

Care of Battery Pack

Under no circumstances should the battery pack be punctured or disassembled in any way. NEVER insert anything into the battery receptacle except a standard cigarette lighter type plug. The battery pack should always be stored in a fully charged condition and in a cool, dry place. When stored for a long period of time, the battery should be charged before use.

Charging

The Battery should be charged after each use. Insert the cigarette lighter type plug of the charger into the receptacle on the side of the battery pack. Plug the charger into any standard 120volt household plug. Depending on the amount of drain on the battery, the following is a guide for recharging time. A 25% discharge requires 4 hours recharging. A 50% discharge requires 8 hours. A 100% discharge requires 14 hours recharging time.

NOTE: The Battery should NOT be left in the Recharging mode for more than 24 hours as this can damage the cell.



CAUTION: DO NOT attempt to charge this battery pack on currents other than 60-cycles 110volt/120volt AC current. Do not attempt to use the battery during charging.

MAINTENANCE OF OUTDOOR SCOREBOARDS

The EVERSAN Outdoor Scoreboards rugged design will provide many years of trouble free performance.

Should you have a problem:

The EVERSAN Outdoor Scoreboard modular design allows easy removal and replacement of all key elements. **Under no circumstances will EVERSAN, INC. pay for service performed on any of our products without expressed written notice from EVERSAN, INC. to the Service Company.**

Note to the customer:

Please call our qualified service technicians if you experience any difficulties. We can assist you in solving your problem or help in returning the section in need of repair.

REMOVAL AND REPLACEMENT PROCEDURES

Should repair become necessary the customer will note that each digit (8) is housed as an individual item within the scoreboard.

- Determine which digit is malfunctioning by observing the check out of 8's during power up or during operation.

To remove or replace digits:

1. REMOVE ALL POWER FROM THE SCOREBOARD.
2. Unscrew the (4) four screws that hold the digit in place and slowly pull the digit away from scoreboard.
3. Detach the 9-pin segment data cable connector by pressing down on the top the latch on the side of the locking connector and pulling up on the connector. The Digit is removed.
4. Take the new digit and connect the 9-pin connector in the scoreboard to the 9-pin connector on back of digit. DO NOT FORCE.

NOTE: The connector is polarized and must be installed in only one direction.

Replacing the (4) four screws that hold the digit into place and test scoreboard. If problem persists please contact Eversan, Inc.

9370/9872 /9874 LCD CABLED CONTROL CONSOLE

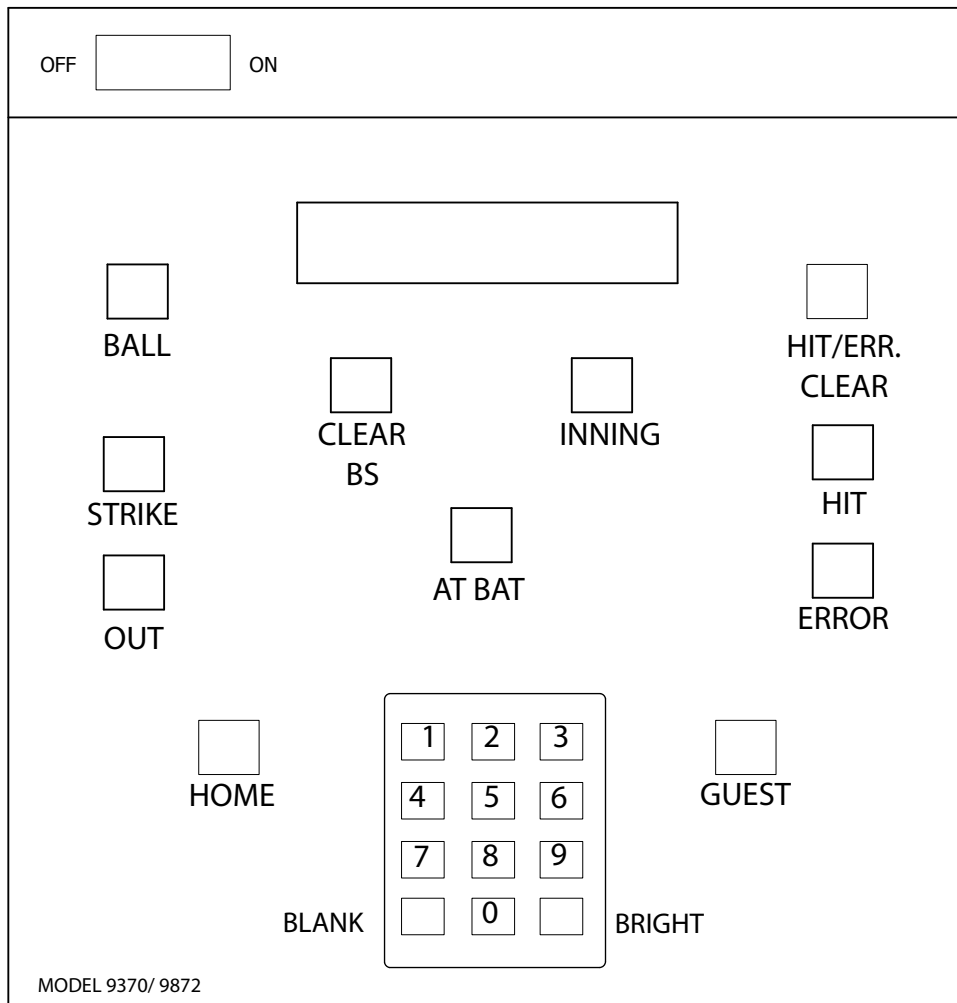
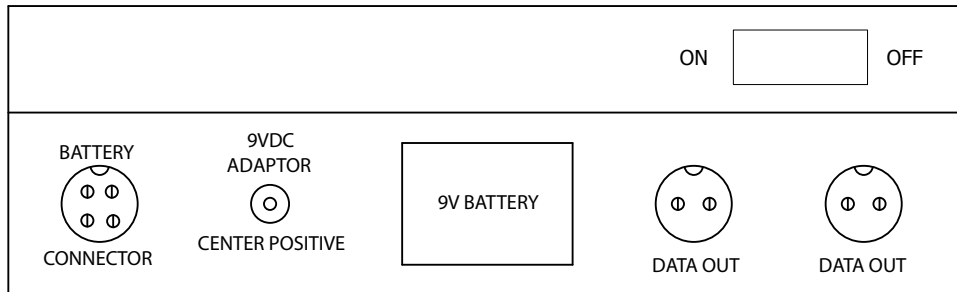

9370/9872 2.4GHZ WIRELESS LCD CONTROL CONSOLE

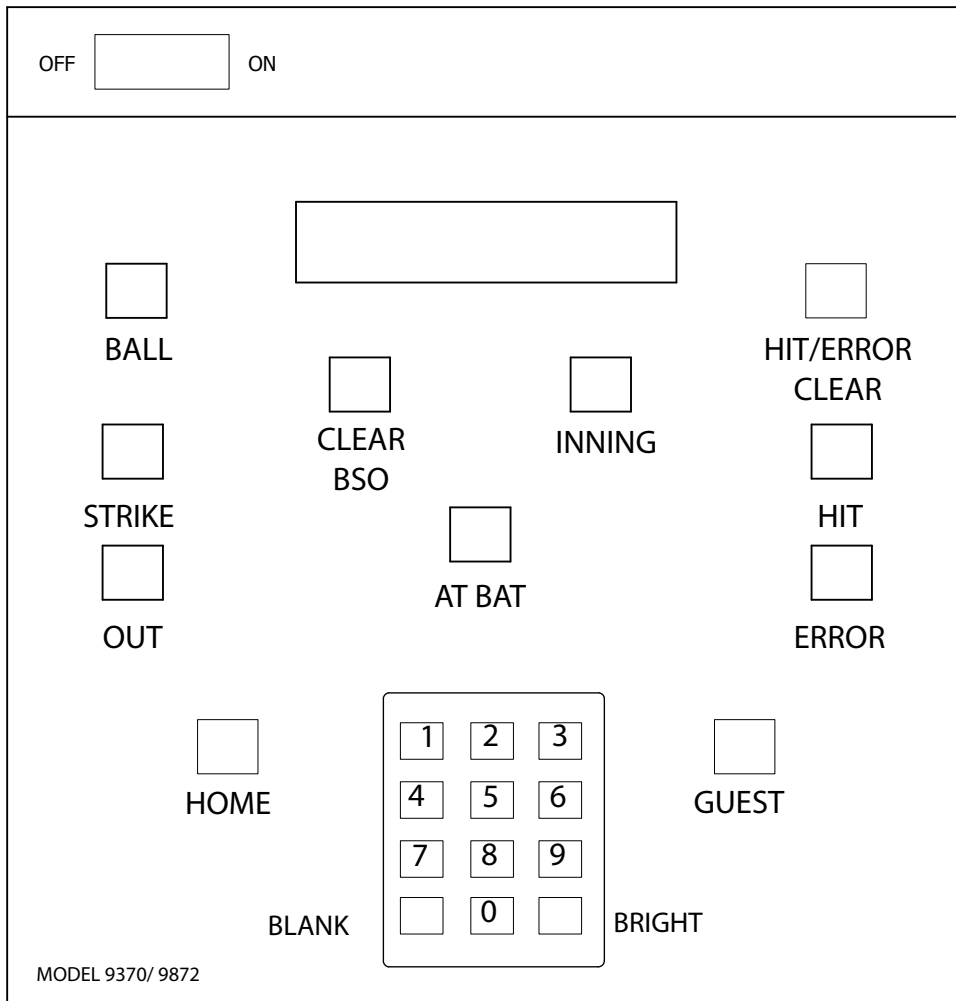
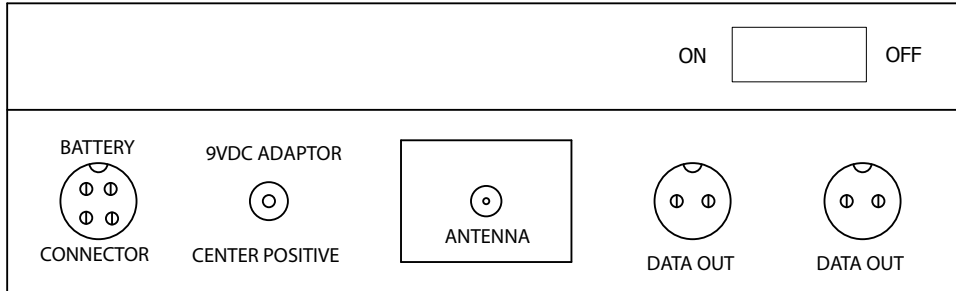



www.eversan.com

**MODEL 9872
BASEBALL/SOFTBALL
SCOREBOARD**

Address: 34 Main Street, Whitesboro, NY 13492

Phone: 315-736-3967 • **Toll Free:** 800-383-6060 • **Fax:** 315-736-4058

SCOREBOARDS • TIMERS • MESSAGE SIGNS • VIDEO DISPLAYS • WIRELESS