



www.eversan.com

MODEL 9360-100



FOOTBALL/TRACK SCOREBOARD

Instruction Manual

Address: 34 Main Street, Whitesboro, NY 13492

Phone: 315-736-3967 • Toll Free: 800-383-6060 • Fax: 315-736-4058

SCOREBOARDS • TIMERS • MESSAGE SIGNS • VIDEO DISPLAYS • WIRELESS

Table of Contents

Check List	1
Installation Instructions.....	2
Instructions for Wiring.....	3
Assembly Drawing	4
Installation Drawing	5
Wireless Operation	6
Football Mode Operating Instructions	6
Track Mode Operating Instructions	7
Cabled Console.....	8
Wireless Console.....	9
Maintenance of Outdoor Scoreboards.....	10
Removal and Replacement Procedures	11



Page 1

**MODEL 9360-100
FOOTBALL SCOREBOARD
WITH 1/100 SECONDS TRACK TIMER**

INSTALLATION AND OPERATING INSTRUCTIONS

These instructions must be followed to ensure correct operation. The warranty will be violated and considered null if inspection and operating procedures are disregarded.

Should you require assistance or have any questions, please call 800-383-6060.

Check List

- Model 9360-100 Scoreboard (2-Sections)
- Control Console with LCD readout
- Two Conductor Control Cable (Cabled Systems Only)
- Mounting Brackets (4)
- Support Brackets (2)
- Antenna (2) (Wireless Systems Only)

NOTE: Please check that these items are available prior to initial test of the scoreboard. If you are missing any items, please call **(800) 383-6060 for assistance.**

Customer Shipping Inspection

- A. Unpack scoreboard.
- B. Unpack cable and control console. Plug the console cable and console into the console connector on back (see diagram).
- C. Assemble scoreboard using the instructions and hardware supplied before testing but prior to hanging the scoreboard.
- D. Testing - Remove four screws holding the panel on the 120VAC access box on the back of the scoreboard. There is a standard 120VAC plug for testing. After testing cut connector provided. Match colors on power cable provided to three wires on 120V box. This board operates on 120VAC at approximately 4 AMP.

**NOTE: FAILURE TO TEST SCOREBOARD PRIOR TO INSTALLATION
WILL VOID ALL WARRANTIES.**

Power scoreboard using 120VAC and test scoreboard using the operating instructions provided.

**SHOULD THERE BE A MALFUNCTION OR SHIPPING DAMAGE,
NOTIFY THE SHIPPER AND EVERSAN IMMEDIATELY.**

INSTALLATION

1. It is recommended that a professional sign company be hired to install the scoreboard (see drawings). Eversan recommends a minimum depth of 6 ft. and a minimum diameter of 2 ½- ft. pylon for each I-beam.
2. Calculate the wind loading by standard formula for height and dimension of sign. Dimension of the sign is 8FT. High x 18FT. Wide. Approximate weight is 400lbs.
NOTE: Check local codes for your area.
3. Prepare and sink 2Ea. I-beams 10FT apart. Minimum I-Beam recommendation W 10 x 15 conforming to ASTM A36, align with plumb line and careful measurements.
4. Determine height of lowest point for scoreboard, minimum recommendation 8FT. Mark and align on all mounting beams parallel to visual ground sighting.
5. Drill and bolt (5/16 bolts) or weld provided bottom Z-brackets to the posts as shown in the installation diagram.
6. Assemble the scoreboard on the ground and test according to the instructions. Make sure to connect connectors between the top, bottom and each side of the scoreboard.
7. Lift scoreboard set onto Z bracket. Secure temporarily with a clamp.
8. Place the top Z-brackets on the board and install in the same manner as the lower.
9. The board is now ready to be wired. Wireless systems must have the antenna installed to the right of Power Supply cover, on the front of the scoreboard. Just screw antenna into connector provided.

INSTRUCTIONS FOR WIRING

1. Determine 120VAC entrance and run conduit to pre-installed electric box on back of scoreboard (see diagram).
2. The scoreboard draws 5 amp, 600 watts, but requires its own circuit breaker. Eversan, Inc. recommends using a 10-amp, GFCI breaker.

CAUTION: Cabled System Only

The data cable is a pre-wired, 2 conductor shielded, 22GA stranded cable. Any cable splicing should be color-coded or failure of the computer power supply will result. Continuity of the shield is essential in reducing possible damage due to lightning.

Electrical Specifications:

Electric outlets for scoreboards are always on a “clean” unused, switched breaker box. Pay close attention to the power source and connections. It is recommended that a key-switch or switched breaker box be used to turn off the system at the end of use each day. **The scoreboard should always be powered down when not in use.**

Power up Sequence:

120VAC Operation (Cabled System)

1. Plug the control console into the scoreboard using the cable provided. Any of the 2-pin connectors on the control console can be used. The connector for the scoreboard is located on the back (see diagram).
2. Power up the scoreboard using 120VAC, connection on back of scoreboard (see diagram).
3. The scoreboard will now go through diagnostics. Each digit will show a dash and then starting at the minutes each digit will show an 8 and then go blank. The scoreboard will then stay blank until the control console is turned on.
4. Turn the control console on using the rocker switch located on the upper left side. The control console will display “WIRELESS NETWORK SYSTEM ID = NO” for approx. 5 seconds. The display will then show, “EVERSAN, INC. DISPLAY SYSTEMS”, and then “PLEASE SELECT 1=FOOTBALL, 3=TRACK. By pressing 1, on the keypad, you will put the console in FOOTBALL mode, pressing 3 will put the console in TRACK mode. You are now ready to use the operating instructions to test all the functions.

Note: If the control console will not power up or shows “BATTERY LOW” replace the battery with a 9V alkaline battery or use the 9-volt adapter provided.

MODEL 9360 SERIES ASSEMBLY INSTRUCTIONS

STEP 1:

INSTALL 2EA. BACK SUPPORTS SUPPLIED TO THE BOTTOM HALF OF THE SCOREBOARD WITH 5/16" BOLTS, WASHERS, AND LOCK WASHERS.



STEP 2:

LIFT THE TOP HALF OF THE SCOREBOARD ONTO THE BOTTOM HALF OF THE SCOREBOARD AND SECURE TO THE BACK SUPPORTS WITH 5/16" BOLTS, WASHERS, AND LOCK WASHERS. BE SURE TO CONNECT 9-PIN DATA CABLE FROM THE TOP HALF OF THE SCOREBOARD TO THE BOTTOM HALF OF THE SCOREBOARD. THE 9-PIN CONNECTOR MUST BE PLUGGED INTO THE 9-PIN CONNECTOR ON THE PRINTED CIRCUIT BOARD UNDER THE ACCESS PANEL.

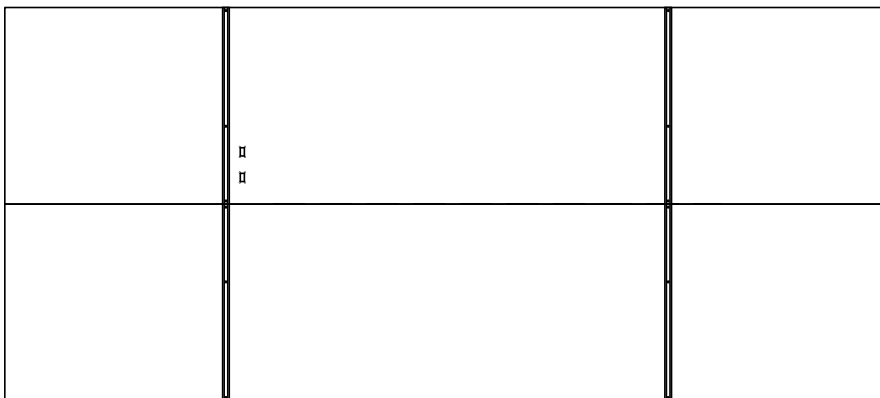

STEP 3: MOUNT ANY SPONSOR/AD PANELS AND RIG SCOREBOARD FOR LIFTING. THEN TEST SCOREBOARD USING THE INSTRUCTIONS. FAILURE TO TEST THE SCOREBOARD PRIOR TO INSTALLATION MAY VOID WARRANTIES.

9360-10 INSTALLATION INSTRUCTIONS

STEP 1:
SET I-BEAMS 10 FOOT APART ON CENTER.

STEP 2:
MOUNT BOTTOM Z-BRACKETS A MINIMUM OF 8' ABOVE GROUND LEVEL.
WELD OR BOLT BRACKETS TO I-BEAMS A MINIMUM OF 8'-3-1/4" FROM THE TOP OF THE I-BEAM (IF NO AD/SPONSOR PANEL).

STEP 3: LIFT SCOREBOARD, USING PROPER RIGGING, INTO BOTTOM Z-BRACKET AND SECURE WITH A TEMPORARY CLAMP.

STEP 4: BOLT OR WELD TOP Z-BRACKETS TO HOLD SCOREBOARD INTO PLACE.

DETAIL A

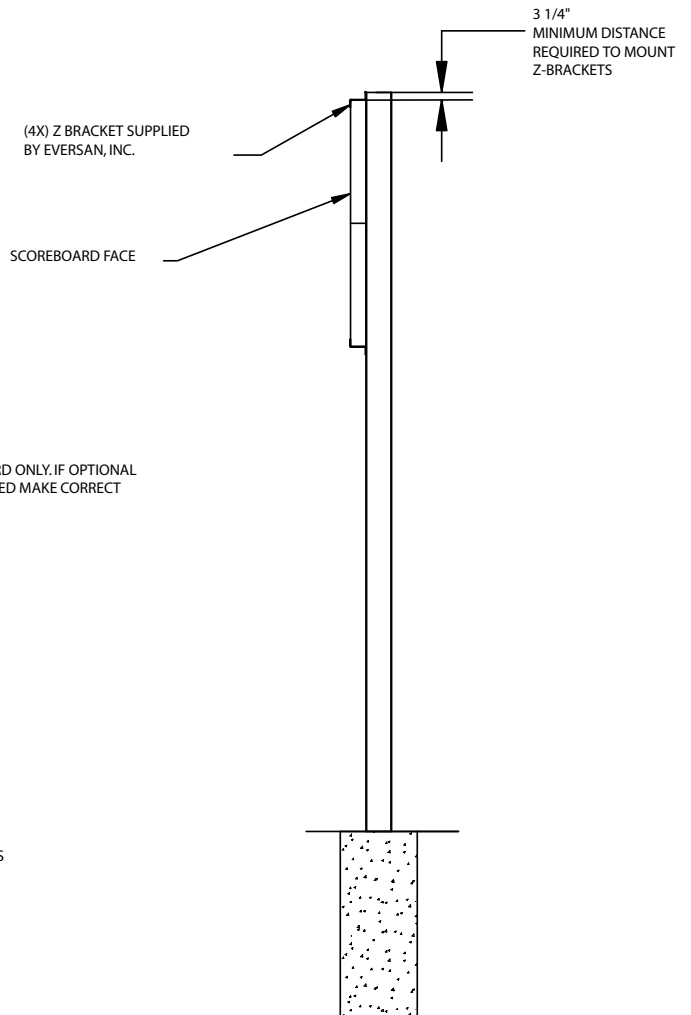
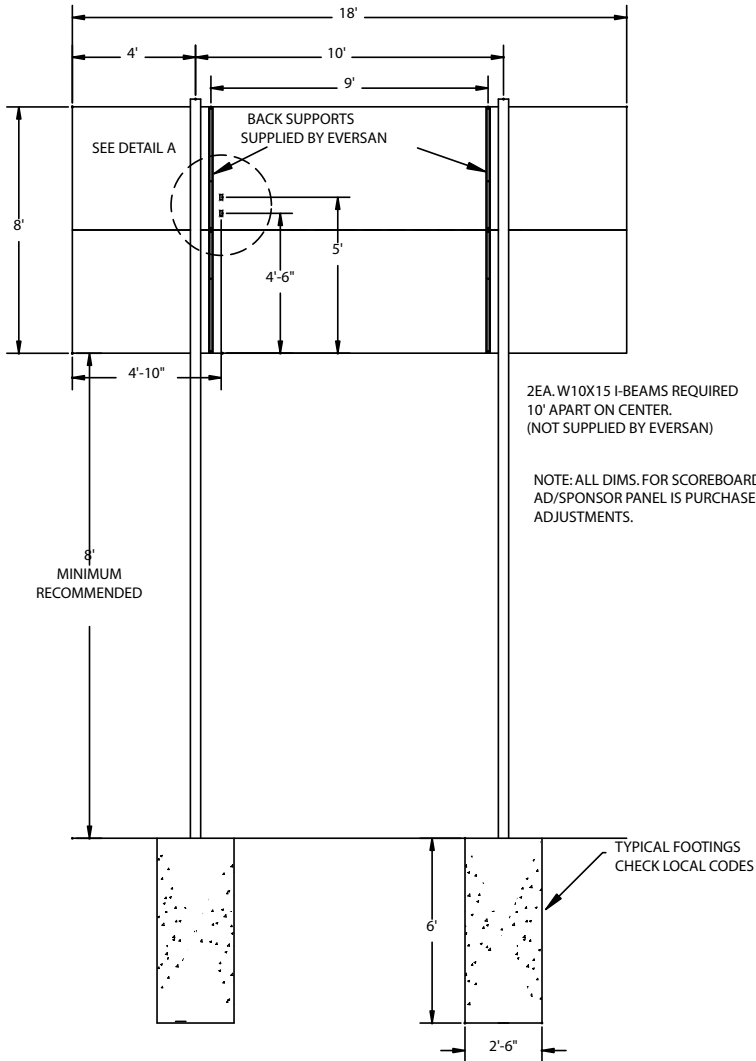
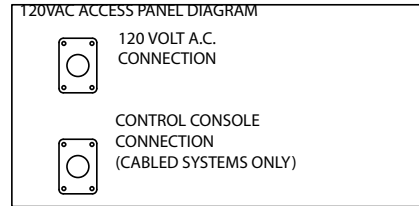

WIRELESS OPERATION

Eversan, Inc.'s 2.4GHZ frequency hopping wireless control system allows for multiple scoreboards to be controlled separately or together within feet of each other.

Initializing the wireless system:

The following steps must be used to ensure proper communication from the 9360-100 wireless control console and each scoreboard you want to control.

1. Turn the power on to each 9360-100 scoreboard that you want to control. The scoreboards will show a dash in each digit location.
2. Connect the antenna, 9VDC adapter provided or optional 12-volt battery, to the 9360-100 wireless control console (see diagram for proper placement).

Turn the control console on using the rocker switch located on the upper left side. The control console will display "WIRELESS NETWORK SYSTEM ID = XX" for approx. 5 seconds. The display will then show, "EVERSAN, INC. DISPLAY SYSTEMS", and then "PLEASE SELECT 1=FOOTBALL, 3=TRACK. By pressing 1, on the keypad, you will put the console in FOOTBALL mode, pressing 3 will put the console in TRACK mode. You are now ready to use the operating instructions to test all the functions.

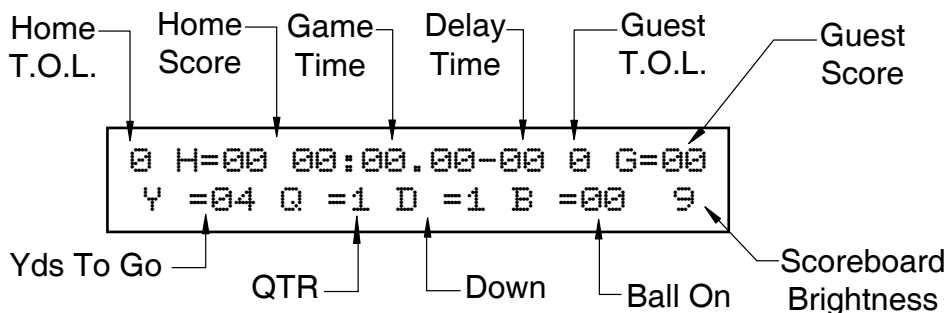

Football Mode Operating instructions:

1. **TO SET TIME:** Press and release the **TIME** button once and enter a (4) Digit number, example 12:00 minutes would be set by pressing and releasing **TIME** followed by 1,2,0,0 via the 0-9 keypad.
2. **TO SET THE SCORE:** Press and release the **HOME** or **GUEST** button once to increment by one. Press and hold down to decrement. Press and release the button and enter any 2-digit number from 0-9 on the numbered keypad, example 06 would be set by pressing and releasing **HOME** or **GUEST** and 0,6 using the 0-9 keypad.
3. **TO SET BALL ON, DOWN or YARDS TO GO:** Press and release the corresponding button once to increment by one. Press and hold down to decrement. Press and release the button and enter any number from 0-9 on the numbered keypad.

- 4. TO SET QTR:** Time must be stopped. Press the **QTR** button once to increment by one. Press and release the button and enter any number from 0-9 on the numbered keypad.
- 5. TO START THE TIME:** Push **GREEN START/ STOP** once. To stop clock push **START/ STOP** again.
- 6. BRIGHTNESS CONTROL:** The illumination displayed by the scoreboard may be controlled by pressing and releasing the **BRIGHTNESS** (red) button on the control console and then pressing 0-9 on the keypad. 9 will make the scoreboard the brightest and 1 will make the scoreboard the dimmest. Zero will blank the scoreboard, but doesn't turn the scoreboard off.
- 7. DELAY OF GAME:** If Eversan, Inc. DELAY of GAME displays are being used in conjunction with the 9362-100 scoreboard attach the remote **RESET** switch to the control console. Pressing and releasing the remote **RESET** switch will reset and start the delay of game clock, default time is 24 seconds. To change the default time press and hold down the remote **RESET** and enter a two-digit time.

Track Mode Operating Instructions:

- 1. STARTING, STOPPING, and RESETTING RACE TIME:** In Track mode the remote switch is used to START, STOP, and RESET the RACE TIME. Pressing and releasing the remote switch once STARTS the RACE TIME. Pressing and releasing the remote switch again STOPS the RACE TIME. With the clock stopped pressing and holding the remote switch for 5 seconds RESETS the RACE TIME to zero.
- 2. TO SET THE SCORE:** Press and release the **HOME** or **GUEST** button once to increment by one. Press and hold down to decrement. Press and release the button and enter any 2-digit number from 0-9 on the numbered keypad, example 06 would be set by pressing and releasing HOME or GUEST and 0,6 using the 0-9 keypad.

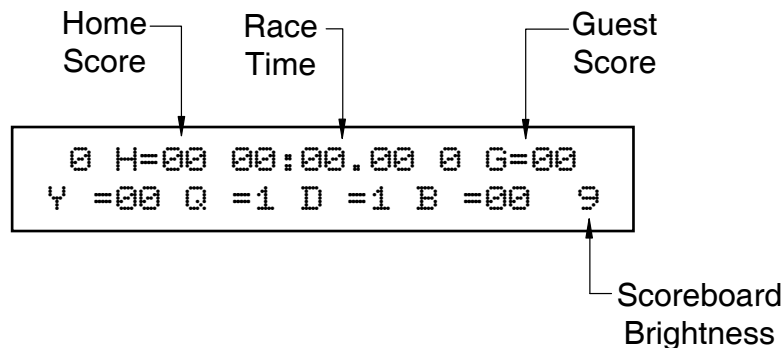

9300 SERIES CABLED LCD CONTROL CONSOLE

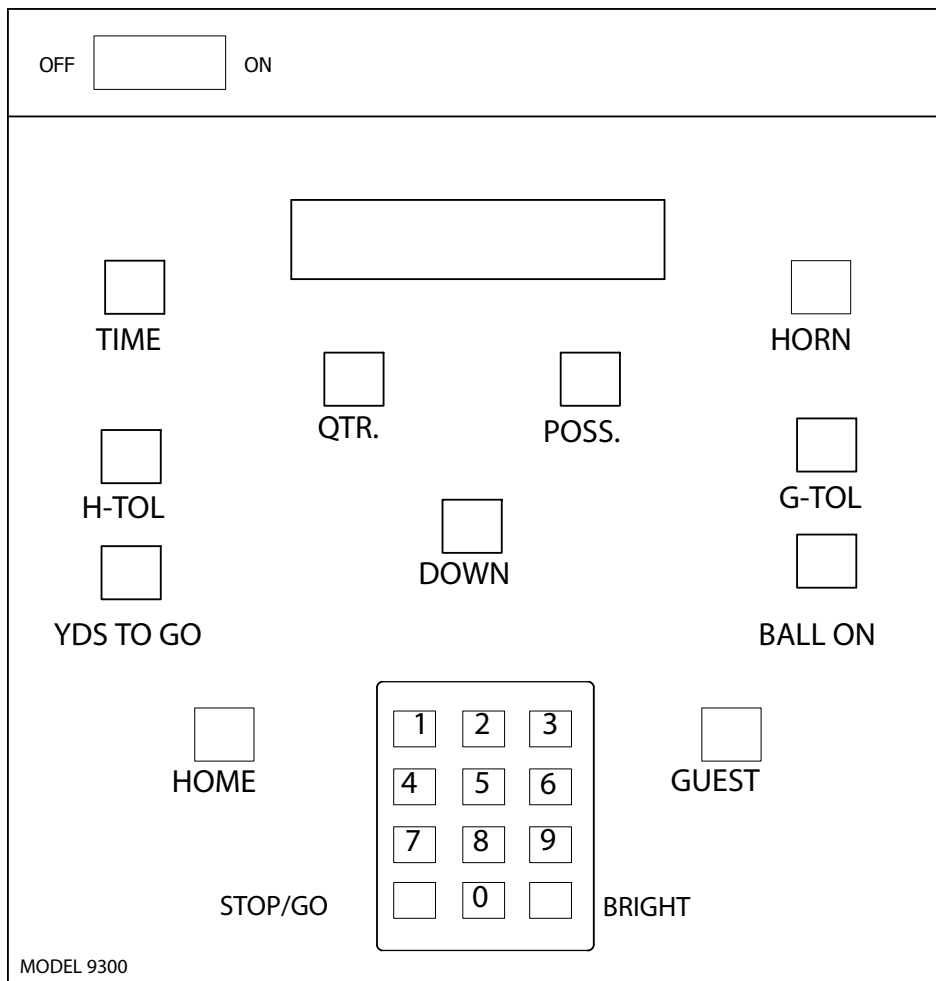
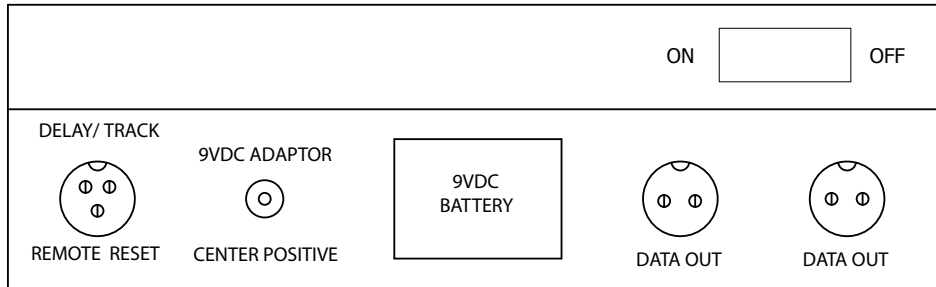

9300 SERIES 2.4GHZ WIRELESS LCD CONTROL CONSOLE

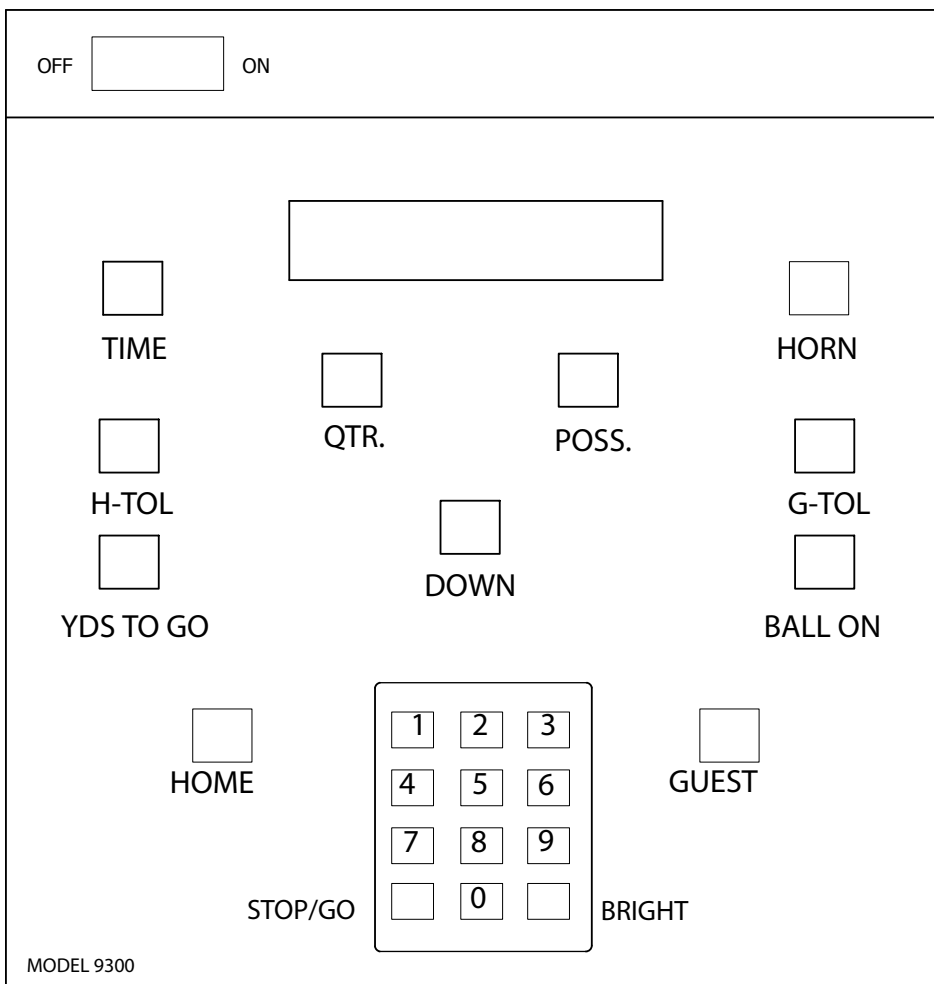
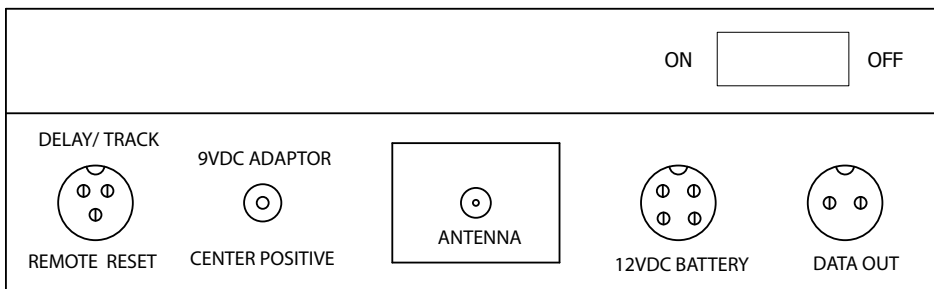

Wireless Control Console Battery Operation: (Optional)

1. Turn the scoreboard power on.
2. Attach Eversan, Inc.'s special battery connector to the 4-pin connector on the back of the wireless control console. (see diagram)
3. Connect the cigarette lighter plug into the Eversan battery pack or a car cigarette lighter.

Care of Battery Pack

Under no circumstances should the battery pack be punctured or disassembled in any way. NEVER insert anything into the battery receptacle except a standard cigarette lighter type plug. The battery pack should always be stored in a fully charged condition and in a cool, dry place. When stored for a long period of time, the battery should be charged before use.

Charging

The Battery should be charged after each use. Insert the cigarette lighter type plug of the charger into the receptacle on the side of the battery pack. Plug the charger into any standard 120volt household plug. Depending on the amount of drain on the battery, the following is a guide for recharging time. A 25% discharge requires 4 hours recharging. A 50% discharge requires 8 hours. A 100% discharge requires 14 hours recharging time.

NOTE: The Battery should NOT be left in the Recharging mode for more than 24 hours as this can damage the cell.

CAUTION: DO NOT attempt to charge this battery pack on currents other than 60-cycles 110volt/120volt AC current. Do not attempt to use the battery during charging.

MAINTENANCE OF OUTDOOR SCOREBOARDS

The EVERSAN Outdoor Scoreboards rugged design will provide many years of trouble free performance.

Should you have a problem:

The EVERSAN Outdoor Scoreboard modular design allows easy removal and replacement of all key elements. **Under no circumstances will EVERSAN, INC. pay for service performed on any of our products without expressed written notice from EVERSAN, INC. to the Service Company.**

Note to the customer:

Please call our qualified service technicians if you experience any difficulties. We can assist you in solving your problem or help in returning the section in need of repair.

REMOVAL AND REPLACEMENT PROCEDURES

Should repair become necessary the customer will note that each digit (8) is housed as an individual item within the scoreboard.

- Determine which digit is malfunctioning by observing the check out of 8's during power up or during operation.

To remove or replace digits:

1. REMOVE ALL POWER FROM THE SCOREBOARD.
2. Unscrew the (4) four screws that hold the digit in place and slowly pull the digit away from scoreboard.
3. Detach the 9-pin segment data cable connector by pressing down on the top the latch on the side of the locking connector and pulling up on the connector. The Digit is removed.
4. Take the new digit and connect the 9-pin connector in the scoreboard to the 9-pin connector on back of digit. DO NOT FORCE.

NOTE: The connector is polarized and must be installed in only one direction.

5. Replacing the (4) four screws that hold the digit into place and test scoreboard. If problem persists please contact Eversan, Inc.



www.eversan.com

**MODEL 9360-100
FOOTBALL
SCOREBOARD**

Address: 34 Main Street, Whitesboro, NY 13492

Phone: 315-736-3967 • **Toll Free:** 800-383-6060 • **Fax:** 315-736-4058

SCOREBOARDS • TIMERS • MESSAGE SIGNS • VIDEO DISPLAYS • WIRELESS