



www.eversan.com

**MODEL 9685
HOCKEY
SCOREBOARD**

Address: 34 Main Street, Whitesboro, NY 13492

Phone: 315-736-3967 • **Toll Free:** 800-383-6060 • **Fax:** 315-736-4058

SCOREBOARDS • TIMERS • MESSAGE SIGNS • VIDEO DISPLAYS • WIRELESS



www.eversan.com

MODEL 9685



HOCKEY SCOREBOARD

Instruction Manual

Address: 34 Main Street, Whitesboro, NY 13492

Phone: 315-736-3967 • Toll Free: 800-383-6060 • Fax: 315-736-4058

SCOREBOARDS • TIMERS • MESSAGE SIGNS • VIDEO DISPLAYS • WIRELESS

Table of Contents

Check List	1
Out of Box Setup and Test	1
Installation Instructions	2
Wiring Instructions	3
Operating Instructions.....	3
Maintenance of Outdoor Scoreboards	5
Installation Diagram	6
Cabled Console	7
Wireless Console	8

9385 SERIES 2.4GHZ WIRELESS LCD CONTROL CONSOLE

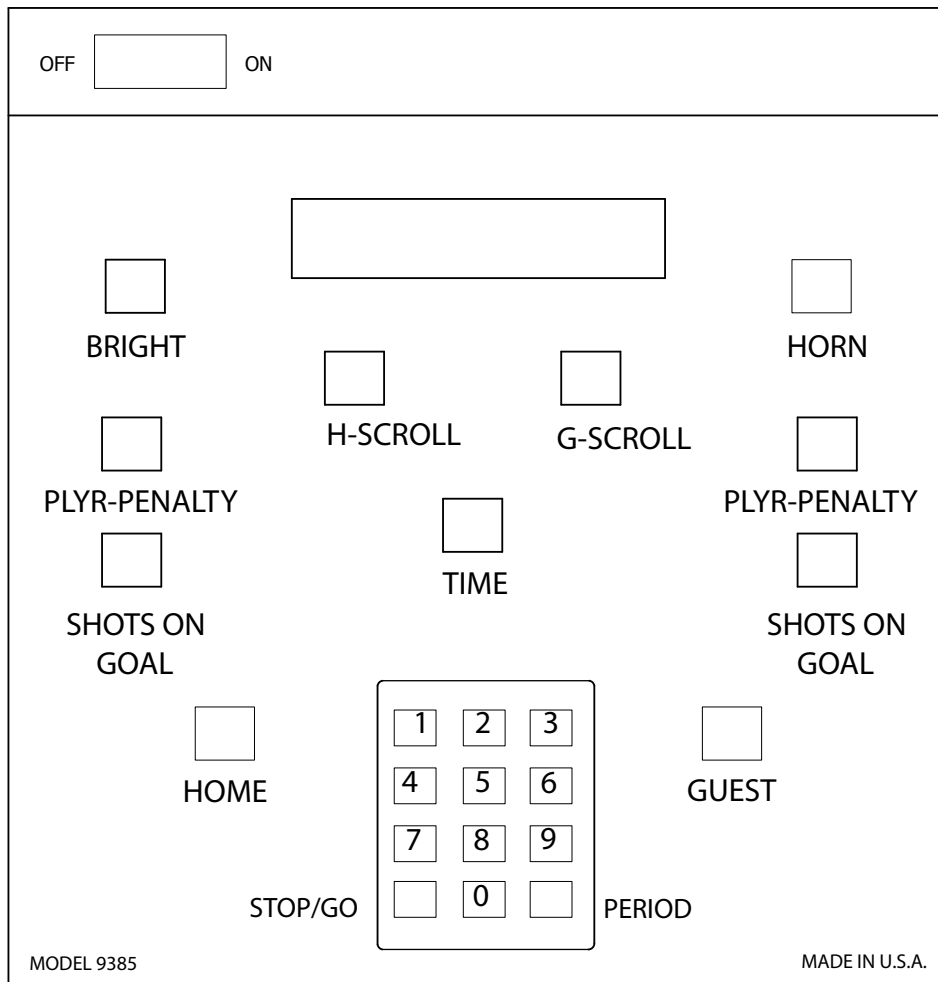
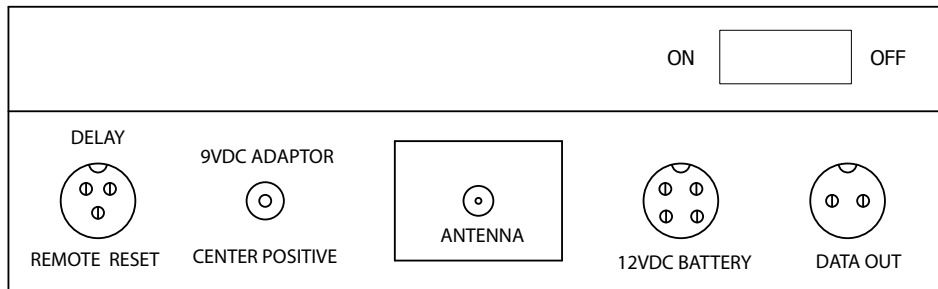

Model 9385 Hockey Scoreboard

Packing List

- One (1) Scoreboard with Two (2) Player Penalty boards.
- One (1) Control Console.
- Two (2) Interconnection data cables from center scoreboard to Penalty boards.
- Two (2) Interconnection four-pin power cables from the center scoreboard to the Penalty boards.
- One (1) Custom Cut Control Cable (A) with Connector and Wall Junction Box
*(Optional) Cable System Only.
- One (1) Custom cut Control Cable (B) with Connectors.(Optional) Cable System Only)
- Two (2) Antenna. (Wireless Option Only)
- Two (2) mounting Z-brackets. (Optional)

NOTE: Please check that these items are available prior to initial test of the scoreboard. If you are missing any items check the all boxes that the parts were shipped in. If parts are still missing please **call (800) 383-6060 for assistance.**

Before You Begin:

ALWAYS connect/disconnect cables before power is turned on.

NEVER service without contacting an Eversan, Inc. Technician.

NEVER service with the power on.

Out of Box Setup and Test

The Eversan, Inc. 9385 series scoreboard system comes complete and ready to operate.

NOTE: Follow these instructions in order to assure correct operation and installation. Warranties will be void if the procedures below are disregarded. **Failure to test scoreboard prior to hanging will void all warranties.**

1. Plug interconnection cables into center scoreboard and penalty boards to establish data link throughout the system. (2-pin connectors) Establish power interconnection (4-pin connection) between the center scoreboard and penalty boards.
2. Plug wall junction box cable (Optional) or Data cable (cabled systems only) to the side of the scoreboard (2-pin connector).
3. Plug the console cable (cabled systems only) into the wall junction box.
4. Plug the console cable to the console. Connect 9V adapter to console.
5. Connect antenna to scoreboard and console (wireless systems only).
6. Plug the scoreboard into a 120VAC outlet or use the optional portable power pack to power the entire system. Upon power up, your cabled scoreboard will check the displays by flashing 8's and going blank. The wireless scoreboard will show dashes in the center section of the scoreboard

while the penalty sections will walk an eight through each number panel.

7. Turn on the control console using the rocker switch on the upper left side. The console will display EVERSAN, INC. SCOREBOARDS for approximately 2-seconds. The console will then display TIME=00:00.0, HOME=00 GUEST=00. The scoreboard will respond and show the matching data with the exception of the minute's digits will remain blank along with the home and guest penalty digits.
8. **If using a wireless system you must always power the scoreboard before turning the control console on.** If you are operating multiple scoreboards with one console you must power all the scoreboards prior to turning on the console. If you are operating multiple scoreboards with multiple consoles. You must turn power on to one scoreboard and then the console you want to use to operate that scoreboard. This allows each system to set automatically so as not to interfere with each other.
9. Go to operating instructions to test scoreboard.

Installation Instructions

1. It is recommended that a professional sign company be hired to install the scoreboard (see drawings). Eversan recommends a minimum footing depth of 5.5 ft. and a diameter of 2.5 ft.
2. Calculate the wind loading by standard formula for height and dimension of sign. The total dimension of the sign is 30IN. High x 13FT. Wide. Approximate weight is 150lbs. Check local codes for your area.
3. Prepare and sink (3) I-beams, minimum I-Beam recommendation W 6 x 15 conforming to ASTM A36, align with plumb line and careful measurements.
4. Determine height of lowest point for scoreboard, minimum recommendation 8FT. Mark and align on all mounting beams parallel to visual ground sighting. Drill the top mounting holes in the face of each I-Beam. There should be two (2) mounting holes per I-Beam top and bottom for a total of twelve (12) holes for the entire installation.
5. Assemble the scoreboard and optional sponsor panel on the ground and test according to the instructions. If optional mounting brackets were purchased the scoreboard may come pre-assembled. If the scoreboard is not assembled use the hardware available to attach the mounting brackets to the back of the entire scoreboard system.
6. Measure the distance between the mounting holes in the I-Beams. Using those measurements drill the mounting holes into the top-mounting bracket attached to the back of the scoreboard.
7. Lift scoreboard into position and secure the top-mounting bracket on the back of the scoreboard to the I-Beam with proper hardware. Temporarily clamp the lower mounting bracket to the I-Beams.
8. Drill the holes required to secure the lower mounting bracket to the I-Beams and secure the lower mounting bracket using the proper hardware.
9. The board is now ready to be wired. Wireless systems must have the antenna installed on the front of the center scoreboard. Just screw antenna into connector provided. The horn must also be installed on the front of the scoreboard to the right of the time.

9385 SERIES 2.4GHZ CABLED LCD CONTROL CONSOLE

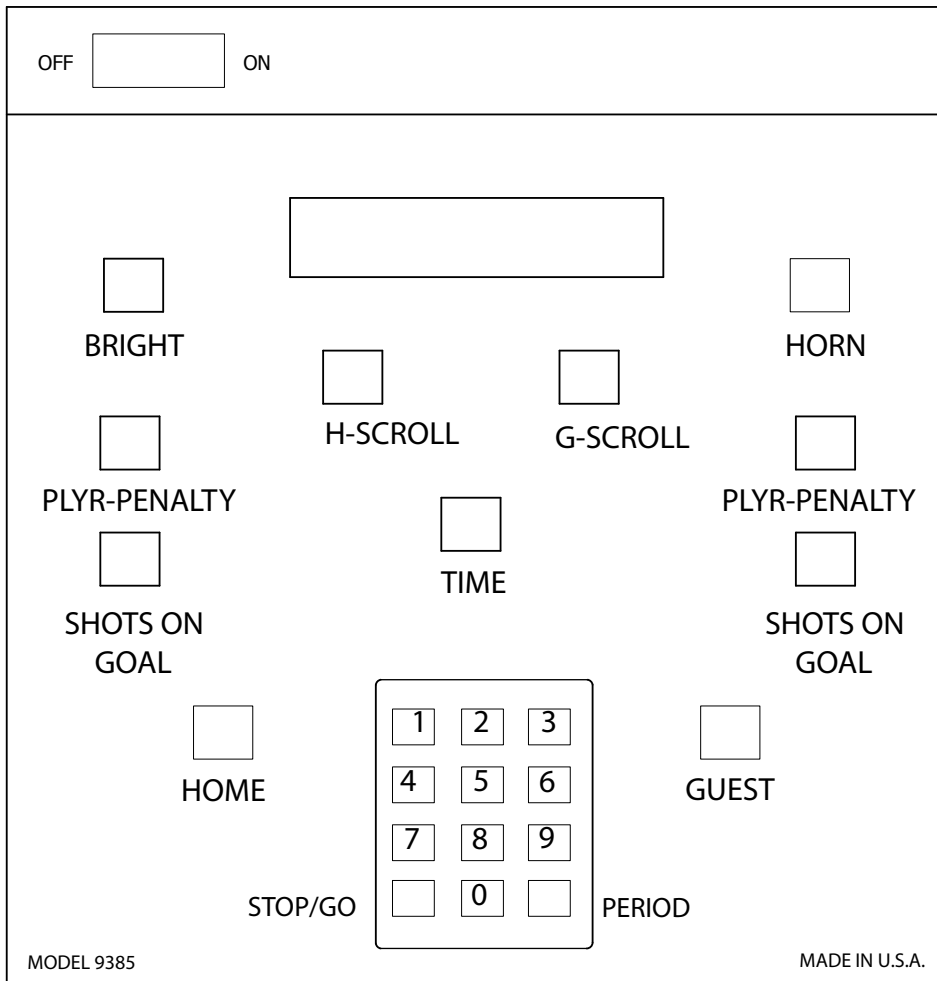
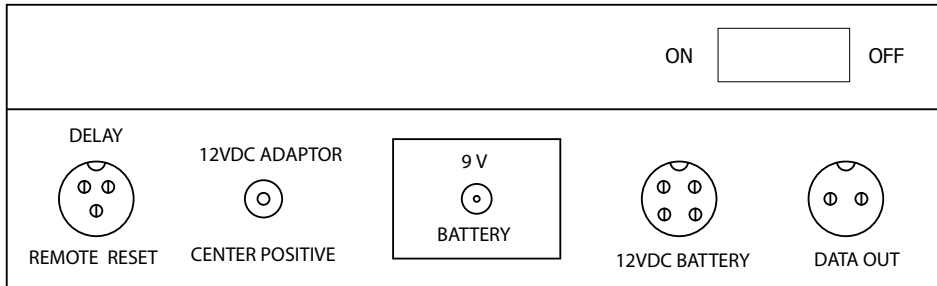

MODEL 9685 INSTALLATION

INSTALL I BEAMS 8FT. APART, ON CENTER, INTO GROUND.

MOUNT Z BRACKETS TO THE THREE SECTIONS OF THE SCOREBOARD.

LOCATE, ON I BEAMS, WHERE SCOREBOARD WILL BE MOUNTED. LIFT SCOREBOARD AND MARK I-BEAMS FOR DRILLING. DRILL HOLES IN I-BEAMS TO SECURE SCOREBOARD. SECURE Z BRACKETS USING AT LEAST 8 1/4IN. BOLTS.

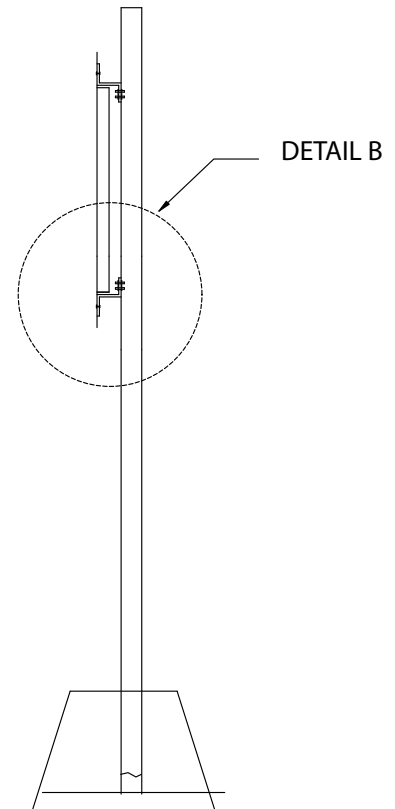

DETAIL A

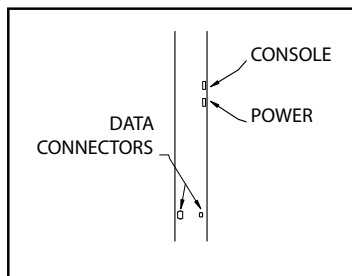

DETAIL B

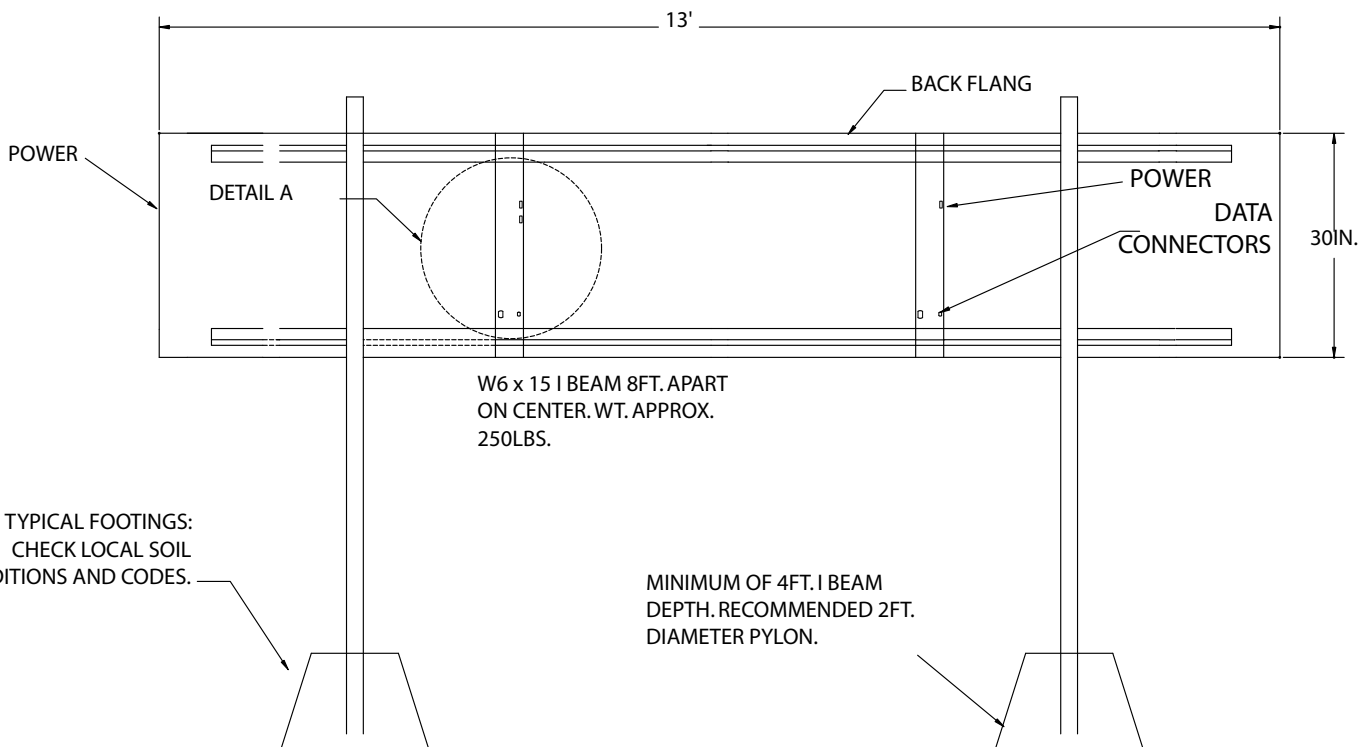
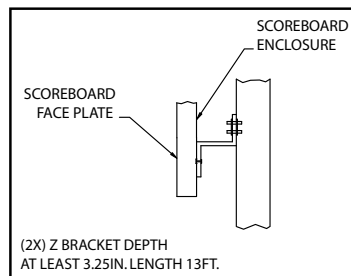



INSTRUCTIONS FOR WIRING

(See Installation Diagram)

Electrical Specifications: Electric outlets for scoreboards are always on a “clean” unused, switched breaker box. Pay close attention to the power source and connections. It is recommended that a key-switch or switched breaker box be used to turn off the system at the end of use each day. **The scoreboard should always be powered down when not in use.**

Power Requirement: 120VAC @ 6 amp for the 9385 scoreboard. Eversan, Inc. recommends using a 10-amp, GFCI, breaker for outdoor scoreboard power. The center section of the scoreboard requires 120VAC. Each penalty section receives power from the center section through a four-pin connection. Connect the four-pin connections between the center and side sections of the scoreboard and then connect the 120VAC to the center section.

Optional Portable Power Pack: A portable rechargeable power pack may be purchased to power this scoreboard. The four-pin round connector on the control console is the input for an optional 12VDC battery.

CAUTION: (Cabled System Only) The data cable is a pre-wired, 2 conductor shielded, 22GA stranded cable. Any cable splicing should be color-coded or failure of the computer power supply will result. Continuity of the shield is essential in reducing possible damage due to lightening. Data cable from the factory is wired as follows: Pin 1 – Red, Pin 2 – Black with the shield being secured to the back shell of the connector using the cable clamp screw.

Operating Instructions

Setting the Time: To set the time the clock must be stopped. Press and release the TIME button and enter a four-digit number using the 0-9 numbered keypad. Example, push and release the TIME button and enter 0-2-0-0 and the clock will show two minutes. If an error has been made, press and release the TIME button and repeat above procedure. The time entered is displayed on both the console’s LCD and scoreboard display.

Starting and Stopping the Clock: The STOP/ GO button for the clock is located on the bottom left side of the 0-9 keypad and is green. Pressing and releasing the button once will start the clock a second time will stop the clock.

Setting the Score: Press the HOME or GUEST button once to increment by one. Press and hold down to decrement. Press and release the button and enter any 2-digit number from 0-9 on the numbered keypad.

Setting the Period: The clock must be stopped to set the period. Press and release the RED button on the 0-9 keypad to increment the period by one. The console LCD display will show each period change, for approximately 5 seconds, on the console and then display the score.

Setting Penalties: The clock must be stopped to enter a penalty. Press and release either HOME PLYR/PENALTY or GUEST PLYR/PENALTY button and enter six-digit number via the keypad. For

example, if you would like to enter player #23 with 1 minute, 30 second penalty time, enter: 2-3-0-1-3-0. When the sixth digit is entered the penalty will be displayed on the scoreboard. The system will automatically keep track of up to 7 players in each penalty box. To clear a penalty, stop the clock, push and release HOME PLYR/PENALTY or GUEST PLYR/PENALTY, enter the player number followed by four zero's.

Scroll: H/SCROLL and G/SCROLL allow you to review the active penalties, players and time left on each penalty. The clock must be stopped to review the penalties. Each time you press and release either H/SCROLL or G/SCROLL one penalty with player number and time left will be displayed on the console. Continue to press and release the button and each active penalty will be displayed in order of entry.

Brightness Control: There are 10 settings to control the brightness of the L.E.D. displays in the scoreboard. To control the brightness press and release the BRIGHT button and then press any number 1-9 on the keypad. The brightest level is 9 and the lowest level is 1. If you press and release the BRIGHT button and then the 0 the scoreboard will be blanked.

Wireless control console battery operation (optional):

1. Turn the scoreboard power on.
2. Attach Eversan, Inc.'s special battery connector to the 4-pin connector on the back of the wireless control console (see diagram).
3. Connect the cigarette lighter plug into the Eversan battery pack or a car cigarette lighter.

Care of Battery Pack

Under no circumstances should the battery pack be punctured or disassembled in any way. NEVER insert anything into the battery receptacle except a standard cigarette lighter type plug. The battery pack should always be stored in a fully charged condition and in a cool, dry place. When stored for a long period of time, the battery should be charged before use.

Charging

The Battery should be charged after each use. Insert the cigarette lighter type plug of the charger into the receptacle on the side of the battery pack. Plug the charger into any standard 120volt household plug. Depending on the amount of drain on the battery, the following is a guide for recharging time. A 25% discharge requires 4 hours recharging. A 50% discharge requires 8 hours. A 100% discharge requires 14 hours recharging time.

NOTE: The Battery should NOT be left in the Recharging mode for more than 24 hours as this can damage the cell.

CAUTION: DO NOT attempt to charge this battery pack on currents other than 60-cycles 110volt/120volt AC current. Do not attempt to use the Battery during charging.



MAINTENANCE OF OUTDOOR SCOREBOARDS

The Eversan Outdoor Scoreboard is a rugged design that will provide many years of trouble free performance.

Should you have a problem:

The Eversan Outdoor Scoreboard is designed to allow the customer to plug in parts for repair or replacement. Please call our qualified service technicians if you experience any difficulties. We can assist you in solving your problem or help in returning the section in need of repair.

REMOVAL AND REPLACEMENT PROCEDURES

All Eversan Scoreboards are designed to provide many years of trouble free performance. The Scoreboards modular design allows the customer to easily remove and replace all key elements.

Please call our qualified service technicians if you experience any difficulties. **Under no circumstances will EVERSAN, INC. pay for service performed on any of our products without expressed written notice from EVERSAN, INC. to the Service Company and the customer.**

Should repair become necessary the customer will note that each digit (8) is housed as an individual item within the scoreboard.

- Determine which digit is malfunctioning by observing the check out of 8's during power up or during operation.

To remove or replace digits:

1. REMOVE ALL POWER FROM THE SCOREBOARD.
2. Unscrew the (2) two screws and slowly pull digits away from scoreboard.
3. Detach the data cable connector by pulling up on the connector.
4. Take the new digit and replace data cable connector in the scoreboard to the connector on back of digit. DO NOT FORCE. **NOTE:** The cable connector is polarized and must be installed in only one direction.
5. Replacing digit is the opposite of removing.